



Products for mobile automation.

ecomat[®]
mobile

Systems for mobile machines



ifm.com/gb/mobile

ecomatmobile Systems for mobile machines.



Close to you!

We are close to our customers worldwide. With our many years of application experience, we support them with the implementation of even unusual or difficult application solutions.

**High quality
creates reliability.**

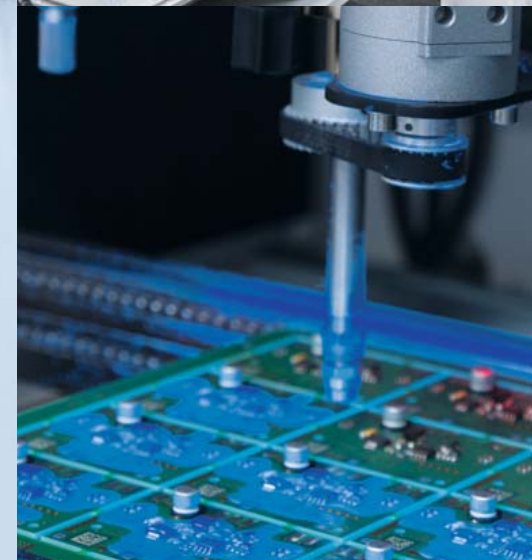

Quality production

A high degree of automation and comprehensive quality controls guarantee continuously high product quality. The complete production process is, of course, certified to ISO standards.



Cannot be shocked

Vibration and shock tests in the shaker simulate the harsh operating conditions. Strong impact and vibrations are part of everyday operation of a mobile machine.



All ifm units have to prove their reliability in extensive tests. Common product tests are enhanced and completed by combined tests such as temperature shock and vibration tests as well as special leak tests, e.g. using high-pressure water jets. Among others, these test procedures lead to protection rating IP 69K that all sensors and connectors for mobile applications have. Before the ifm products go to the customer they are all submitted to a 100 % final inspection.

Only these measures allow ifm to guarantee the quality and reliability they promise the customer.



Checked for reliable operation

Quality is a decisive factor for ifm: After final assembly, comprehensive tests are performed on each individual product. Only units with the test result "functions correctly" leave the factory.

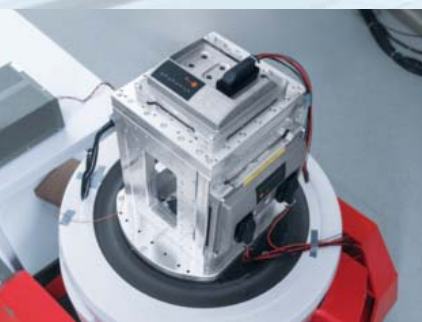

For extreme climates

Simulation of different climatic zones at the climate lab. Among others the switch-on behaviour of the ecomatmobile components is tested at extreme temperatures.



Always the first choice. Robust, flexible, reliable.



Construction machines



Agriculture and forestry







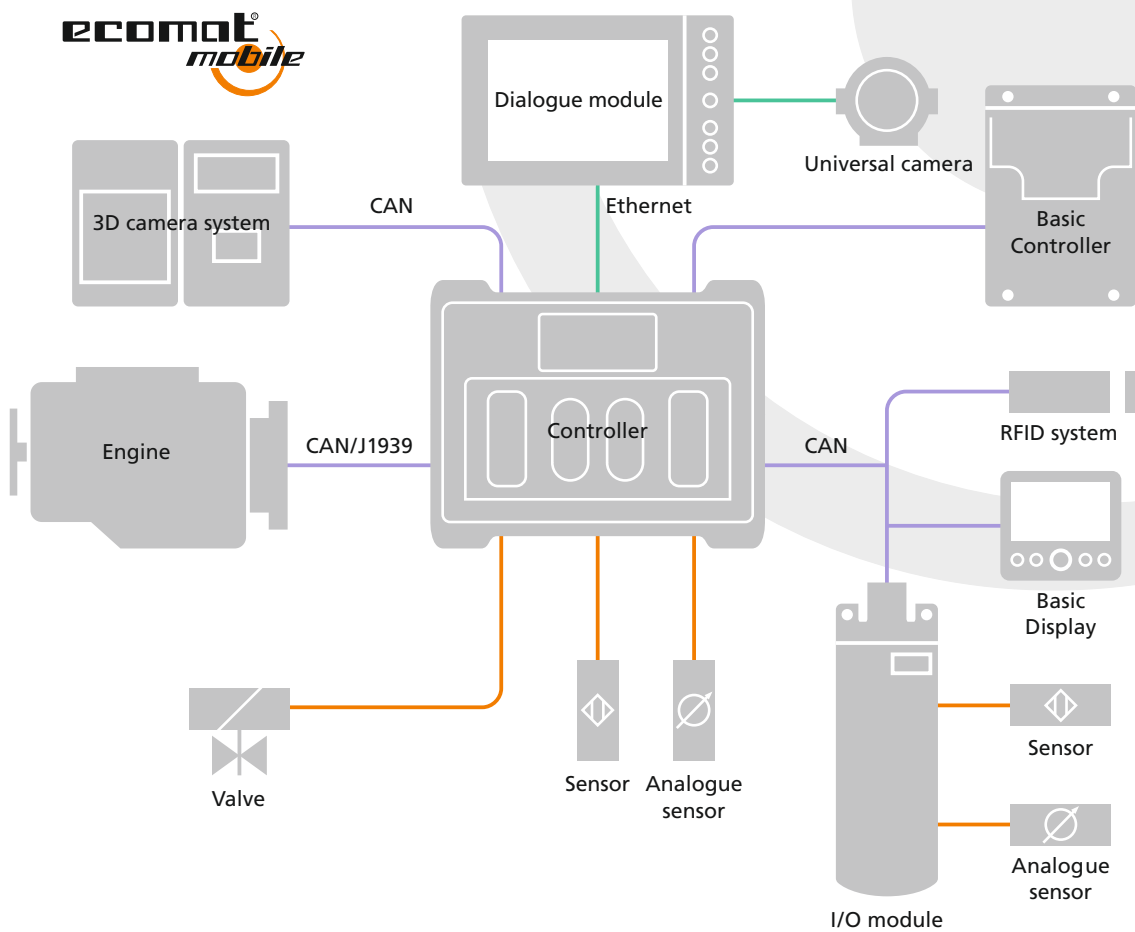

Transport and logistics



Municipal vehicles





| | | | |
|---|---|--|---------|
|  | Controllers | Mini controllers Compact controllers | 8 - 11 |
|  | I/O modules | Modules for applications inside the control cabinet Modules for field applications | 12 - 15 |
|  | Devices for operation and monitoring tasks | Dialogue modules with display sizes from 2.8" to 12" | 16 - 19 |
|  | Cameras for mobile applications | 3D sensors Cameras | 20 - 23 |
|  | Diagnostic and service units | Devices for remote maintenance CAN bus diagnostic units CAN-USB interface cable Software | 24 - 27 |
|  | Sensors for mobile applications | Inductive sensors Magnetic sensors Encoders / inclination sensors Pressure sensors Temperature sensors RFID | 28 - 39 |
|  | Connection technology and accessories | Cable Accessories for controllers Dialogue modules I/O modules | 40 - 43 |

Compact and flexible. ecomatmobile controllers.

Controllers



Powerful:
32-bit controller and CAN interface.

Robust:
Resistant to shock load, vibration, moisture, dirt and extreme ambient temperatures.

Reliable:
Versions for use in safety-related applications.

Simple:
Standardised programming to IEC 61131-3 with CODESYS.

Flexible:
Configurable I/O ports – digital, analogue, PWM.

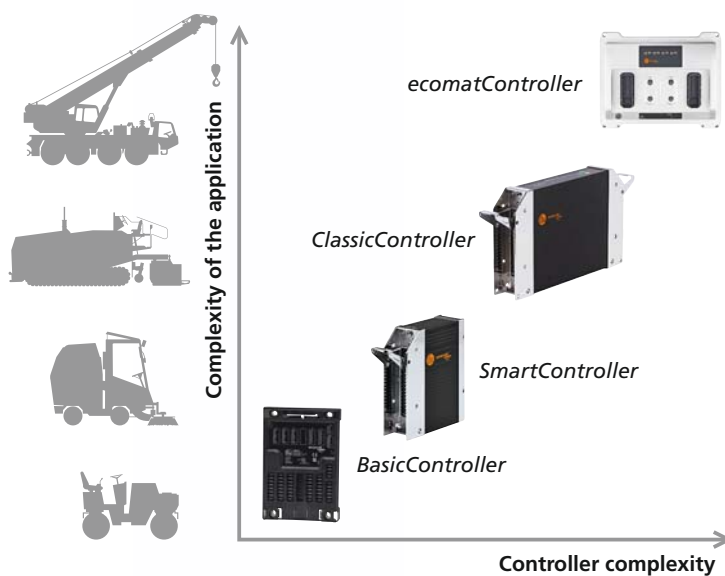

Controllers
accessories
page 42



Powerful mobile controllers for various tasks.

Powerful 32-bit microcontrollers ensure very short cycle times.

The large program memory enables the processing of complex application programs. A second integrated micro controller monitors important system functions.

In addition to digital inputs and outputs the controller also has analogue ports. Inputs for fast signals up to 30 kHz can also be used.

All inputs and outputs are protected against interference and overload.

Wide-range power supplies enable operation in 12 and 24 V on-board systems.

Gateway functions.

Almost all controllers feature several CAN interfaces which are used to transmit data via the CANopen protocol, e.g. to the decentralised input / output modules

or to a dialogue module. Controllers with more than one CAN interface can also be used as a gateway. This enables, for example, direct processing of control and diagnostic data of diesel engines with the SAE J1939 protocol.

Programmable to IEC 61131-3.

With the programming via CODESYS to IEC 61131-3, programming is clear and simple for the user. Function libraries are available for special hardware functions (for example gateway SAE J1939 / CANopen).



ClassicController.

The ClassicController is a proven process controller for a variety of mobile vehicles. It assumes complex working and controlling functions up to driving functions.

Devices for operation and monitoring tasks pages 16 -19



Compact and flexible. ecomatmobile controllers.

Controllers



The new ecomatmobile Basic starter set. Your introduction to mobile control technology.
Order no. EC0400

Mini controllers

BasicController

Modular and cost-effective mini controller.



| Inputs / outputs in total | Inputs | Outputs | Order no. |
|---------------------------|---|---|-----------|
| 20 | 12 x digital, 4 x analogue (U/I), 4 x frequency, 4 x resistance | 8 x digital, 8 x PWM | CR0401 |
| 24 | 12 x digital, 4 x analogue (U/I), 4 x frequency, 4 x resistance | 12 x digital, 2 x PWM-I, 10 x PWM | CR0403 |
| 16 | 8 x digital, 4 x analogue (U/I), 4 x frequency, 4 x resistance | 8 x digital, 8 x PWM-I, 8 x PWM, 4 x H-bridge | CR0411 |
| 14 | 8 x digital, 4 x analogue (U/I), 4 x frequency, 4 x resistance | 6 x relay | CR0431 |

SmartController

Cost-effective mini controller in robust metal housing with protection rating IP 67.



| Inputs / outputs in total | Input / output functions | Order no. | |
|---------------------------|---|-----------------------------------|--------|
| 32 | 16 x digital, 4 x analogue (U/I), 4 x frequency, 2 x resistance | 16 x digital, 2 x PWM-I, 12 x PWM | CR2530 |
| 64 | 32 x digital, 8 x analogue (U/I), 8 x frequency, 4 x resistance | 32 x digital, 4 x PWM-I, 24 x PWM | CR2532 |

Compact controllers

ClassicController

Powerful 32-bit mini controller in robust metal housing with protection rating IP 67.



| Inputs / outputs in total | Inputs | Outputs | Order no. |
|---------------------------|---|--|-----------|
| 32 | 16 x digital, 16 x analogue (U/I), 16 x frequency | 16 x digital, 16 x PWM-I, 16 x PWM, 2 x H-bridge | CR0032 |
| 32 | 32 x digital, 12 x analogue (U/I), 12 x frequency, 4 x resistance | 16 x digital, 16 x PWM-I, 16 x PWM, 2 x H-bridge | CR0033 |
| 80 | 32 x digital, 32 x analogue (U/I), 32 x frequency | 48 x digital, 32 x PWM-I, 32 x PWM, 4 x H-bridge | CR0234 |
| 80 | 40 x digital, 36 x analogue (U/I), 36 x frequency, 4 x resistance | 40 x digital, 32 x PWM-I, 32 x PWM, 4 x H-bridge | CR0235 |
| 64 | 32 x digital, 16 x analogue (U/I), 16 x frequency, 6 x resistance | 32 x digital, 18 x PWM-I, 28 x PWM, 2 x H-bridge | CR0133 |

SafetyController

Reliable, powerful 32-bit controller in robust metal housing with protection rating IP 67.



| Safety | | | |
|--------|---|--|--------|
| 32 | 16 x digital, 16 x analogue (U/I), 16 x frequency | 16 x digital, 16 x PWM-I, 16 x PWM, 2 x H-bridge | CR7032 |
| 80 | 32 x digital, 32 x analogue (U/I), 32 x frequency | 48 x digital, 32 x PWM-I, 32 x PWM, 4 x H-bridge | CR7132 |



ecomatController

- ① Application-specific-configurable user information (HMI).
- ② Coded plug.
- ③ Ethernet interface with internal switch.
- ④ Robust aluminium housing with high protection rating IP 69K.
- ⑤ Plug and play CAN and RS232 interfaces.



Compact controllers

ecomat controllers

Powerful 32-bit standard and safety PLC (SIL 2 / PL d) with large application memory.

Multifunctional inputs and outputs with diagnostic capabilities, two Ethernet and four CAN interfaces.

The CAN interfaces support all important bus protocols (CANopen, CANopen Safety and J1939).

Programming with CODESYS V3.5.



| Inputs / outputs in total | Inputs | Outputs | Order no. |
|---------------------------|---|---|----------------------------|
| Safety | | | |
| 37 | 8 x analogue (U/I) 8 x frequency, 4 x resistance | 6 x digital, 1 x analogue 6 x PWM-I 2.5 A, 4 x H-bridge | CR710S¹⁾ |
| 60 | 4 x digital, 16 x analogue (U/I) 8 x frequency, 4 x resistance | 9 x digital, 1 x analogue, 3 x PWM-I 4.0 A, 9 x PWM-I 2.5 A, 6 x H-bridge | CR711S |
| 98 | 16 x digital, 24 x analogue (U/I) 16 x frequency, 4 x resistance | 12 x digital, 2 x analogue, 4 x PWM-I 4.0 A, 12 x PWM-I 2.5 A, 8 x H-bridge | CR720S |
| 124 | 24 x digital, 24 x analogue (U/I) 16 x frequency, 4 x resistance | 18 x digital, 1 x analogue, 6 x PWM-I 4.0 A, 18 x PWM-I 2.5 A, 12 x H-bridge | CR721S |

¹⁾device in preparation

Robust I/O modules for field applications and in the control cabinet.

I/O modules

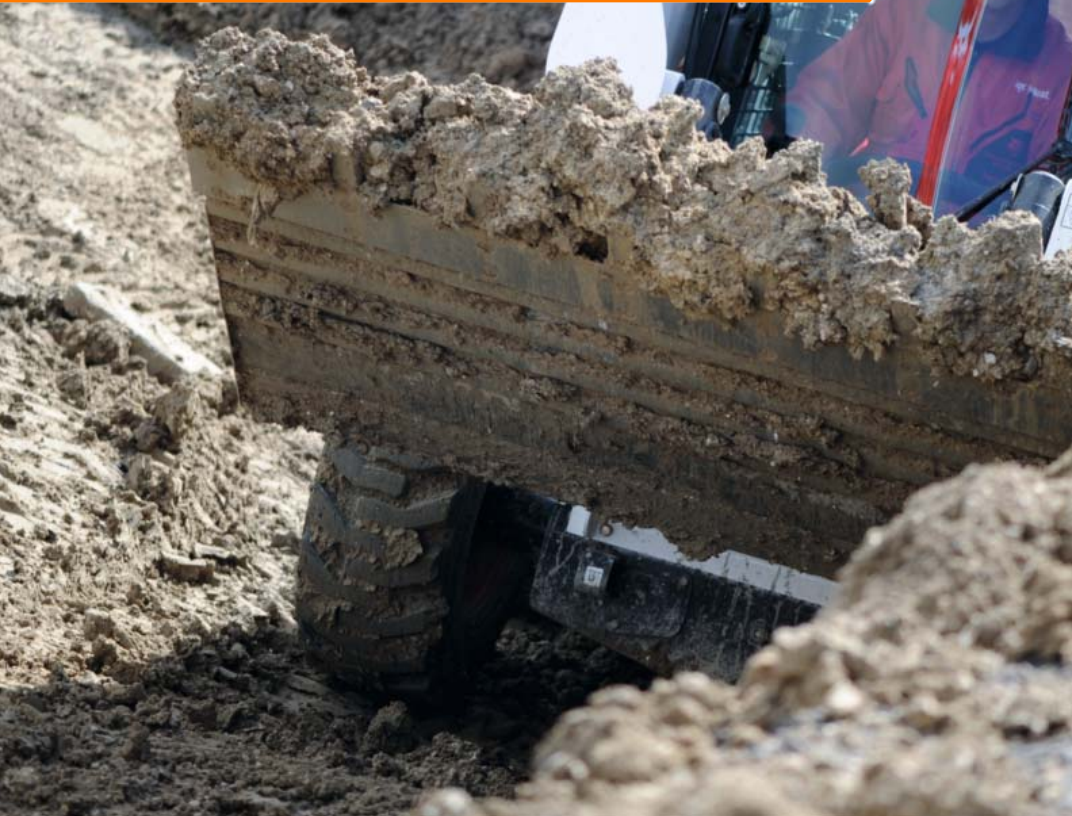

Adaptable:

Configurable input/output functions.

Convenient:

Direct connection of hydraulic valves or joysticks.

Options:

Modules with M12 connectors or central connectors.

Communicative:

CAN interface for various communication tasks.

Permitted:

E1 type approval by the Kraftfahrt-Bundesamt (German Federal Motor Transport Authority).

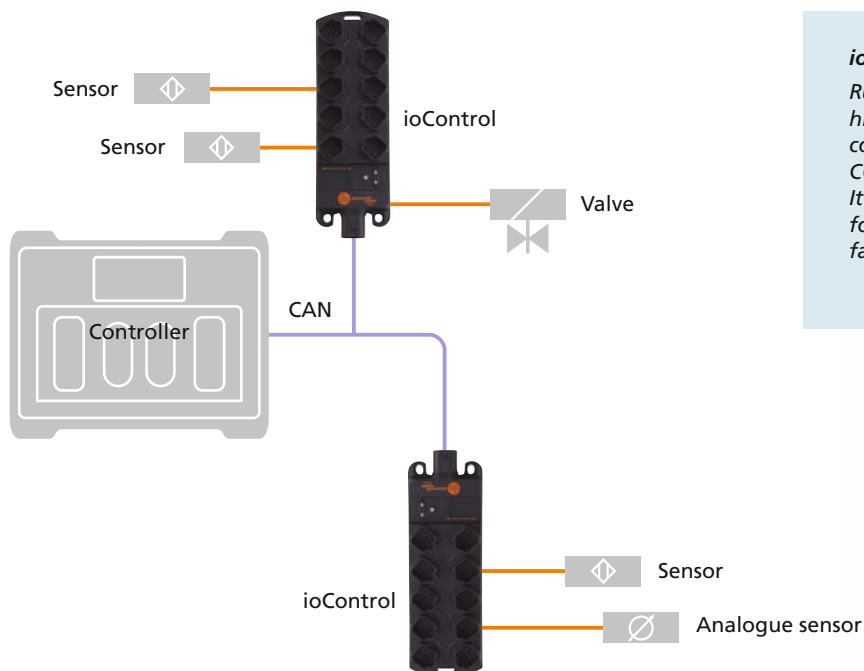

ioControl

Rugged module with integrated controller, high protection rating and DEUTSCH connectors. It can be used as independent, CODESYS-programmable mini controller. It features a display and keyboard interface for parameter setting and two CAN interfaces with CANopen and J1939 protocol.



Decentralised connection to the controller

Decentralised I/O modules connect binary and analogue sensors and actuators to the mobile controller.

They enable decentralised evaluation of sensor signals and control of actuators or proportional valves. Data output and parameter setting of the device functions is handled via a CAN interface.

The modules are particularly suited for mobile machinery such as construction equipment, agricultural machines or municipal vehicles.

The ifm product range includes models with digital, analogue and frequency inputs combined with digital or PWM outputs.

Modules for field use feature high protection ratings as well as shock and vibration resistance. The units offer increased EMC levels and hold an E1 type approval.

Modules to be installed in driver's cabs, control panels or control boxes serve to connect operating and display elements to the CAN bus.

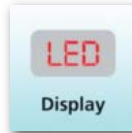
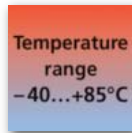

Robust I/O modules for field applications and in the control cabinet.

I/O modules

CabinetModules

Among other things, the modules serve to connect operating and display elements to the CAN bus in mobile machines. They are designed for easy installation in driver's cabs, control panels or control boxes.

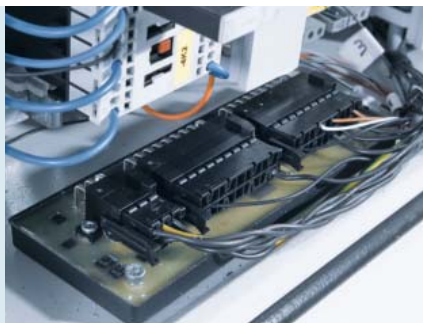

Modules for applications inside the control cabinet

CabinetController

Inputs and outputs for digital and analogue signals.

For use in cockpit or operating panels.



| Inputs / outputs in total | Inputs | Outputs | Order no. |
|---------------------------|---|--------------------------|-----------|
| 16 | 16 x digital, 4 x 0...10 V | 4 x digital, 2 x PWM | CR2012 |
| 16 | 16 x digital, 4 x 0...5 V | 4 x digital, 2 x PWM | CR2014 |
| 32 | 16 x digital, 4 x analogue, 4 x frequency | 16 x digital, 4 x PWM | CR2016 |

Modules for field applications with central connector

I/O module

I/O module in robust metal housing with protection rating IP 67.



| Inputs / outputs in total | Inputs | Outputs | Order no. |
|---------------------------|-------------------------------|--------------|-----------|
| 12 | 4 x digital | 8 x digital | CR2512 |
| 30 | 15 x digital, 4 x analogue | 15 x digital | CR2520 |



- ① DEUTSCH or M12 connector version with protection rating IP 67.
- ② 16 freely configurable inputs and outputs.
- ③ Pushbuttons for easy parameter setting.
- ④ Central connector for power outputs and CAN interface.
- ⑤ Display for parameter setting and for the indication of freely programmable application displays.

Modules for field applications with M12 or DEUTSCH connector

ioControl

Can be used as independent, CODESYS-programmable mini controller.

Display and keyboard interface for parameter setting.

Configurable input / output function.

Two CAN interfaces with CANopen and J1939 protocol.



| Inputs / outputs in total | Inputs | Outputs | Connection | Order no. |
|---------------------------|---|----------------------|------------|----------------------|
| 16 | 8 x analogue, 4 x frequency, 4 x resistance | – | M12 | CR2040 ¹⁾ |
| 16 | – | 8 x digital, 8 x PWM | M12 | CR2041 ¹⁾ |
| 16 | 4 x analogue, 4 x resistance | 4 x digital, 4 x PWM | M12 | CR2042 ¹⁾ |
| 16 | 8 x analogue, 4 x frequency, 4 x resistance | – | DEUTSCH | CR2050 |
| 16 | – | 8 x digital, 8 x PWM | DEUTSCH | CR2051 |
| 16 | 4 x analogue, 4 x resistance | 4 x digital, 4 x PWM | DEUTSCH | CR2052 |

¹⁾device in preparation

M12 I/O module

I/O module in robust metal housing with protection rating IP 67.

Configurable input / output function.

CAN interface.



| Inputs / outputs in total | Inputs | Outputs | Connection | Order no. |
|---------------------------|---------------------------|---------------------------------|------------|-----------|
| 8 | – | 8 x digital, 4 x PWM, 4 x PWM-I | M12 | CR2031 |
| 16 | 8 x digital, 4 x analogue | 8 x digital, 4 x PWM | M12 | CR2032 |
| 12 | 8 x digital, 4 x analogue | 4 x digital, 4 x PWM | M12 | CR2033 |

Visualisation – flexible and ideal. ecomatmobile displays.

Devices for operation and monitoring tasks

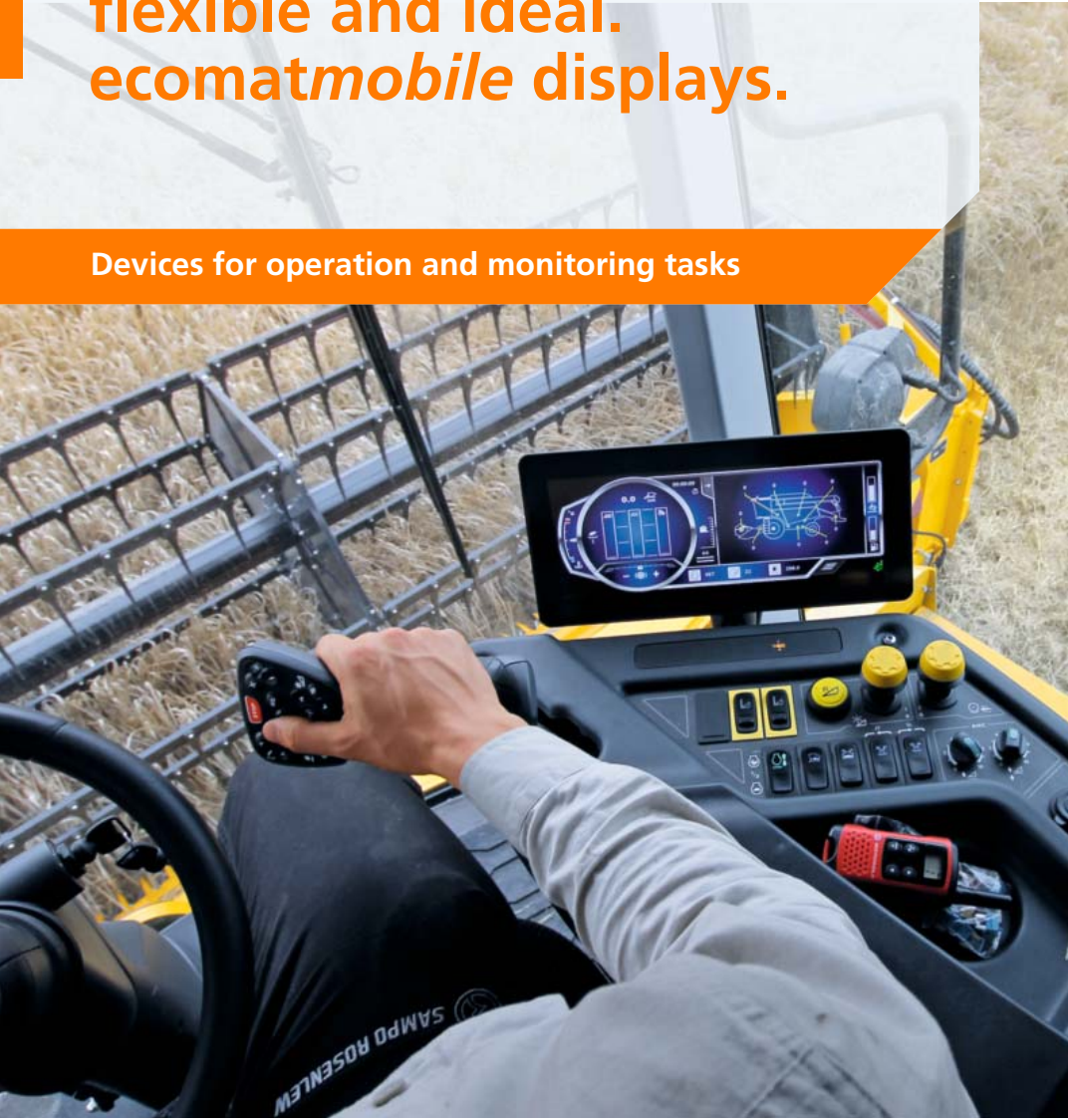

Informative:

Monochrome or colour displays with graphics capabilities and operating elements.

Adaptable:

Programmable to IEC 61131-3 with CODESYS.

Universal:

Robust housing for surface or panel mounting.

Suitable for use with camera:

Versions with interface for cameras for mobile use.

Communicative:

CAN interface for various communication tasks.

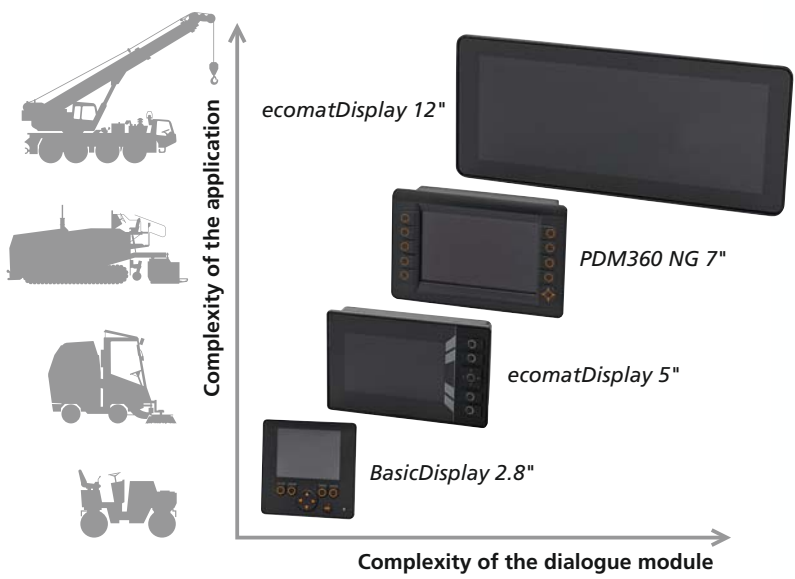

Camera image

Some types have an analogue video input for connection to a mobile camera, for example in order to monitor the area behind a municipal vehicle.



In dialogue with the mobile machine

Dialogue modules are programmable graphic displays for controlling, parameter setting and operation of mobile machines and installations. They can be used in conjunction with a mobile controller or as a stand-alone solution.

Data and device functions are safely transferred via CAN interfaces.

The displays feature many freely programmable backlit function keys. Some types are equipped with an additional navigation key, a potentiometer with pushbutton function or a touch screen.

The units offer increased EMC levels and hold an E1 type approval. Thanks to the high protection rating of the housing, the

modules are suited for outside panel and surface mounting as well as for cabin installation in construction machines, agricultural machinery or municipal vehicles.



O2M camera with analogue video output



Camera systems pages 20 - 23



Visualisation – flexible and ideal. ecomatmobile displays.

Devices for operation and monitoring tasks

Human machine interface

Situation-dependent machine parameters are displayed. The user can change values or release machine functions by activating integrated function and navigation keys.



Dialogue modules with display sizes up to 4.3"

BasicDisplay

Colour display.

CAN interface.

Protection rating
IP 65, IP 67.



| Display Size / resolution | Operating elements | Order no. |
|---------------------------|---|-----------|
| 2.8" / 320 x 240 | 5 freely programmable backlit function keys, navigation key for cursor function, matt film | CR0451 |
| 4.3" / 480 x 272 | 6 freely programmable backlit function keys, navigation key for cursor function, matt film | CR0452 |
| 2.8" / 320 x 240 | 5 freely programmable backlit function keys, navigation key for cursor function, clear film | CR9221 |
| 4.3" / 480 x 272 | 6 freely programmable backlit function keys, navigation key for cursor function, clear film | CR9222 |

Dialogue modules with display sizes up to 12"

PDM360 NG

Colour display.

Inputs / outputs:

1 x digital / analogue input, 1 x digital output.

Interfaces:

4 x CAN, 2 x USB, 1 x Ethernet, 2 x video.

Protection rating
IP 65, IP 67.



| Display Size / resolution | Operating elements | Order no. |
|---------------------------|---|-----------|
| 7" / 800 x 480 | 8 freely programmable backlit function keys | CR1083 |
| 7" / 800 x 480 | 9 freely programmable backlit function keys, navigation key for cursor function, touch screen | CR1082 |
| 7" / 800 x 480 | 9 freely programmable backlit function keys, encoder with pushbutton | CR1084 |
| 7" / 800 x 480 | 9 freely programmable backlit function keys, navigation key with pushbutton | CR1085 |
| 12" / 1024 x 768 | 13 freely programmable backlit function keys, navigation key with pushbutton | CR1200 |
| 12" / 1024 x 768 | 13 freely programmable backlit function keys, navigation key with pushbutton, touch screen | CR1201 |



ecomatDisplay



Integrated interfaces for Ethernet, CAN, USB and analogue cameras.

Powerful processor with additional graphic processor.

- ① *Display with "optical bonding" and a resolution of up to 1280 x 480 pixels.*
- ② *Comprehensive software package for graphical design and programming.*
- ③ *Freely programmable keys with RGB background illumination.*
- ④ *Optional: capacitive touch screen.*

Dialogue modules with display sizes up to 12"

ecomatDisplay
Colour display.
Diecast aluminium housing.
Protection rating IP 65, IP 67.
Programming to IEC 61131-3 with CODESYS V3.5.



| Display Size / resolution | Operating elements | Order no. |
|---------------------------|---|----------------------|
| 5" / 16:10 / 800 x 480 | 4 function keys, navigation key with pushbutton, 1 x Ethernet, 2 x CAN, 1 x USB, touch screen | CR1058 ¹⁾ |
| 5" / 16:10 / 800 x 480 | 4 function keys, navigation key with pushbutton, 1 x Ethernet, 4 x CAN, 1 x USB, 2 x video input | CR1059 ¹⁾ |
| 7" / 16:10 / 800 x 480 | 6 function keys, navigation key with pushbutton, 1 x Ethernet, 2 x CAN, 1 x USB | CR1074 ¹⁾ |
| 7" / 16:10 / 800 x 480 | 6 function keys, navigation key with pushbutton, 1 x Ethernet, 4 x CAN, 1 x USB, 2 x video input, digital I/O | CR1075 ¹⁾ |
| 7" / 16:10 / 800 x 480 | 6 function keys, navigation key with pushbutton, 2 x Ethernet, 4 x CAN, 2 x USB, 4 x video input, digital I/O | CR1076 ¹⁾ |
| 7" / 16:10 / 800 x 480 | 6 function keys, navigation key with pushbutton, 2 x Ethernet, 4 x CAN, 2 x USB, 4 x video input, digital I/O, touch screen | CR1077 ¹⁾ |
| 12" / 8:3 / 1280 x 480 | 1 x Ethernet, 4 x CAN, 1 x USB, 2 x video input, digital I/O | CR1202 ¹⁾ |
| 12" / 8:3 / 1280 x 480 | 2 x Ethernet, 4 x CAN, 2 x USB, 4 x video input, digital I/O, touch screen | CR1203 ¹⁾ |

¹⁾device in preparation

Three-dimensional detection of scenes. Automatic detection of objects.

Cameras for mobile applications



For the harshest environments:

Since the sensor does not have any moving components, it is virtually free of wear. Its high ambient temperature range of -40...85 °C is the basis for universal use.

Long range:

Range of up to 15 m in typical environments and up to 35 m on reflective objects.

Communicative:

Interfaces such as CAN with J1939 or CANopen and fast Ethernet are integrated as standard. Self-diagnostic functions inform about the system status at any time.

Reliable and fast:

With a highly developed algorithm from the automotive sector and a frame rate of up to 50 frames / second the sensor allows fast and reliable calculation of the 3D information.

Positioning and docking help for airport ground equipment

More than 1,000 individual measurements precisely detect the environment of the vehicle. When approaching an aircraft the speed is automatically reduced depending on the distance until the vehicle comes to a complete stop.



Driver assistance during reversing

To prevent accidents the danger zone behind the fork lift is detected in 3D and the driver is informed in time by a warning message before a possible collision. Simultaneously the machine control system can get a command to lower the speed.

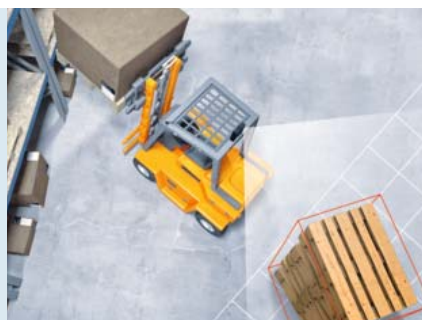

Window recognition

The mobile 3D sensor assumes window recognition and provides the information for automatic steering to the machine control system. At the same time the quantity of material [m³/s] is determined to avoid overloading or underloading of the baler.



Augmented reality – now in real 3D

The PMD 3D sensor from ifm detects scenes and objects three-dimensionally with only one image capture. This avoids the motion blur that can occur with line scanners. ifm's award-winning patented PMD technology forms the basis for a sensor system that can cope with the harsh operating conditions of mobile machines. Besides the robust and compact design the 3D sensor system is especially designed for outdoor applications with changing light conditions or bright sunlight. The ifm 3D sensor has no moving components in contrast to other sensors such as laser scanners.

Therefore it is particularly robust and not subject to wear.

The so far unique combination of PMD 3D sensor and 2D camera with integrated overlay function allows a completely new perception. Overlay of customer-specific symbols, warning messages, texts and even drawings of complex, geometric shapes is supported by the new 3D smart camera system. The request for overlay can either be event-controlled or directly triggered by the machine control system via CAN bus.

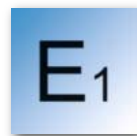
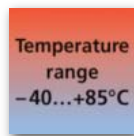

Intelligent collision avoidance

The 3D system for the side loader automatically detects objects such as pedestrians or cyclists in the danger zone. Lowering is immediately stopped. Refuse trucks can enter tight spaces even without a banksman utilising the 180° field of view of the system monitoring the area behind the vehicle.



Three-dimensional detection of scenes. Automatic detection of objects.

Cameras for mobile applications

3D sensors

O3M PMD 3D sensor

2D image with 3D distance information, available as pure camera or sensor with integrated evaluation.

Easy area surveillance in ports

The integrated functions in the 3D sensor are especially suited for monitoring the rails of a gantry crane. The sensor detects an obstacle on the rails or extending into the path and signals this to the crane driver in time. The crane is stopped automatically in critical situations.



Cameras

O2M camera with analogue video output

Aluminium housing, with lens heating.



| Design | Angle of aperture [°] | Mirror function | Order no. |
|-------------|-----------------------|-----------------|-----------|
| CMOS camera | 78 | – | O2M200 |
| CMOS camera | 78 | Integrated | O2M201 |
| CMOS camera | 115 | – | O2M202 |
| CMOS camera | 115 | Integrated | O2M203 |

E2M2xx monitor with analogue video input

Connection of up to four cameras with analogue video signal (with E2M235 video switch).



| Design | Order no. |
|--|-----------|
| 7" TFT LCD monitor with LED backlight for direct connection of an O2M2 camera or O3M2 smart camera. With video input. Resolution WVGA 800 x RGB x 480. | E2M231 |
| 7" TFT LCD monitor with LED backlight for direct connection of O2M2 cameras and / or O3M2 smart cameras. With two video inputs. Resolution WVGA 800 x RGB x 480. | E2M232 |

More information?
Order your
Camera systems
for mobile machines
brochure now!
o3m.ifm



| Design | Angle of aperture horizontal x vertical [°] | Sensor Order no. | Suitable illumination Order no. |
|---|---|------------------|---------------------------------|
| Mobile 3D sensor without data preprocessing ¹⁾ | 70 x 23 | O3M150 | O3M950 |
| Mobile 3D sensor with integrated 2D camera ¹⁾ | 70 x 23 (3D) 90 (2D) | O3M250 | O3M950 |
| Mobile 3D sensor without data preprocessing ¹⁾ | 95 x 32 | O3M160 | O3M960 |
| Mobile 3D sensor with integrated 2D camera ¹⁾ | 95 x 32 (3D) 120 (2D) | O3M260 | O3M960 |
| Mobile 3D smart sensor ²⁾ | 70 x 23 | O3M151 | O3M950 |
| Mobile 3D smart sensor with integrated 2D/3D overlay | 70 x 23 (3D) 90 (2D) | O3M251 | O3M950 |
| Mobile 3D smart sensor ²⁾ | 95 x 32 | O3M161 | O3M960 |
| Mobile 3D smart sensor with integrated 2D/3D overlay | 95 x 32 (3D) 120 (2D) | O3M261 | O3M960 |

¹⁾Synchronous output of the 2D IR image and the 3D distance image as input information for customer-specific image processing
²⁾incl. Application wizards

Application wizards for 3D sensors of types O3M151 / O3M161 / O3M251 / O3M261

| Application wizards available in the ifm vision wizard | Application examples |
|--|--|
| Collision avoidance as driver assistance | Monitoring the area behind the construction vehicles and fork lifts, monitoring the blind spots, collision detection when moving forwards, collision detection on dockside cranes. |
| Area surveillance for mobile or stationary machinery | Area surveillance on drilling rigs, refuse trucks and cranes. |
| Automatic following for driverless transport vehicle | Automatic tracking of transport vehicles ahead and keeping safety distances. |
| Line guidance | Automatic windrow recognition and calculation of the volume flow, automatic steering of a grape harvester. |

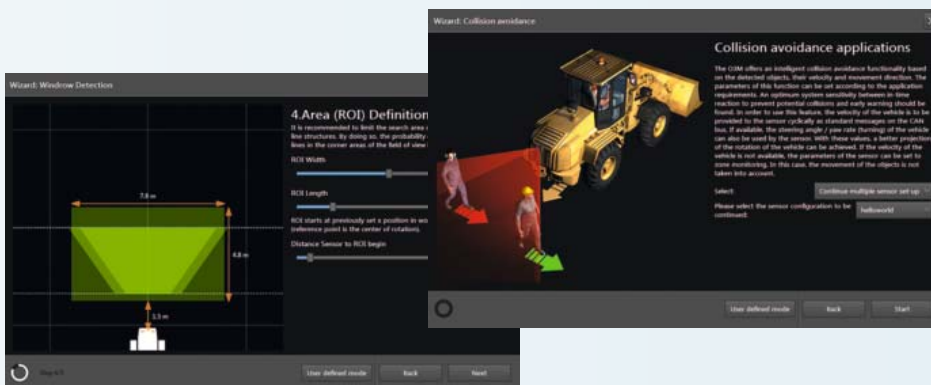

Set-up collision warning.

Easy set-up and handling

The 3D sensor system is set up and operated via ifm's user-friendly Vision Assistant. Its use ensures intuitive parameter setting of even complex configurations with several 3D sensor systems.

Diagnostics and service, convenient and communicative.

Components for diagnostic and service units



Service friendly:

On-site diagnostics or remote diagnostics possible.

Global:

Quad-band radio modem for world-wide use.

Communicative:

High-performance CAN interface for various communication tasks.

Available:

Communication in real time or via the internet portal.

Logging:

Data logging directly on the mobile vehicle.

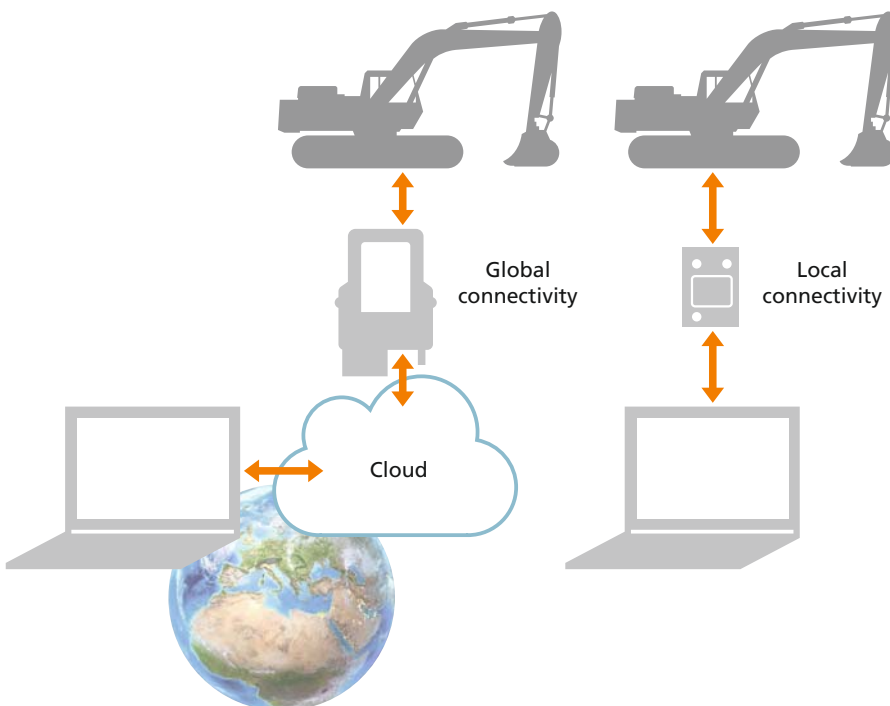



From remote maintenance to route detection

Diagnostic and service units are used for CAN system analysis, for remote maintenance and for position and route detection of mobile machines such as construction equipment, agricultural and forestry machinery, municipal vehicles and vehicles for transport and logistics.

Wireless systems – CANremote as a radio modem with integrated gateway, for example – help enable remote maintenance.

CANwireless allows the user to locally access the machine using Bluetooth or wifi.

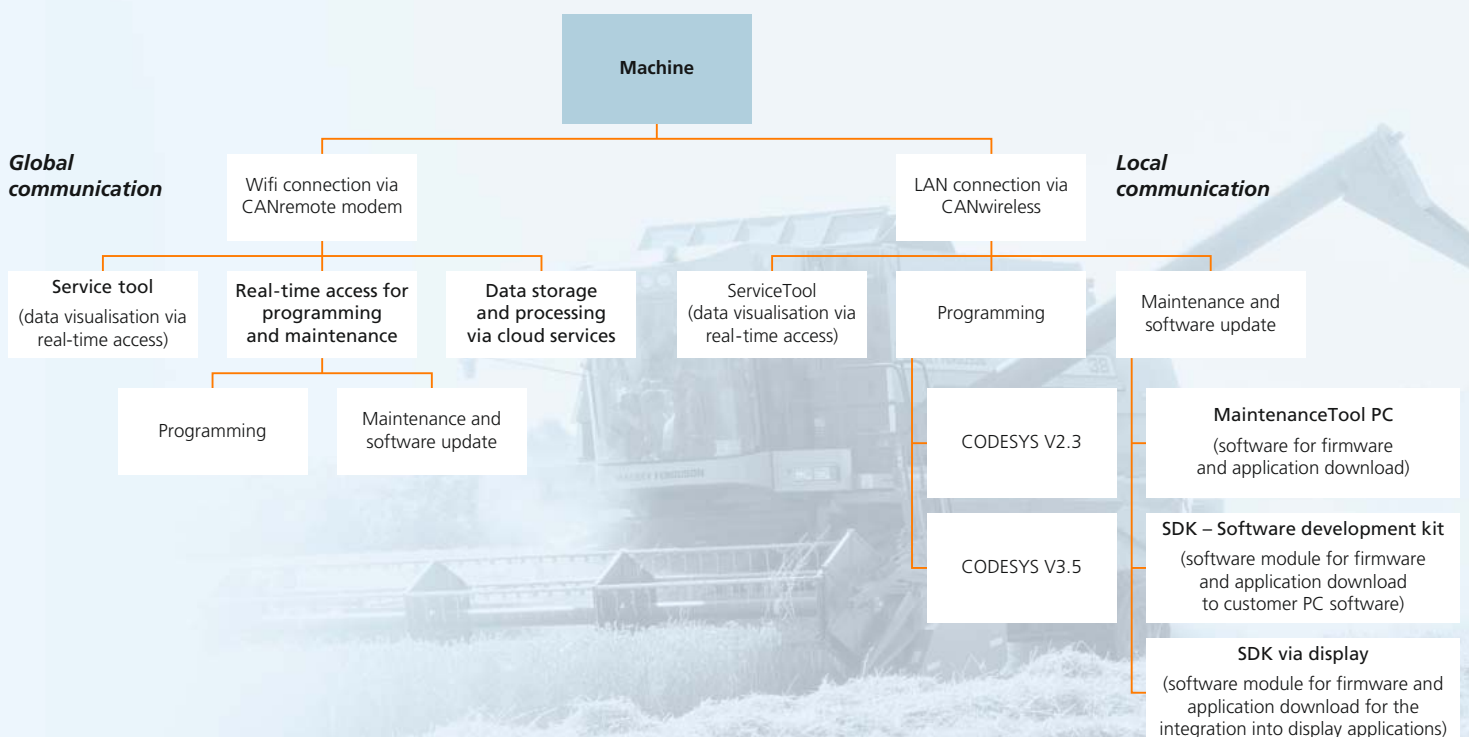

Diagnostics and service, convenient and communicative.

Components for diagnostic and service units

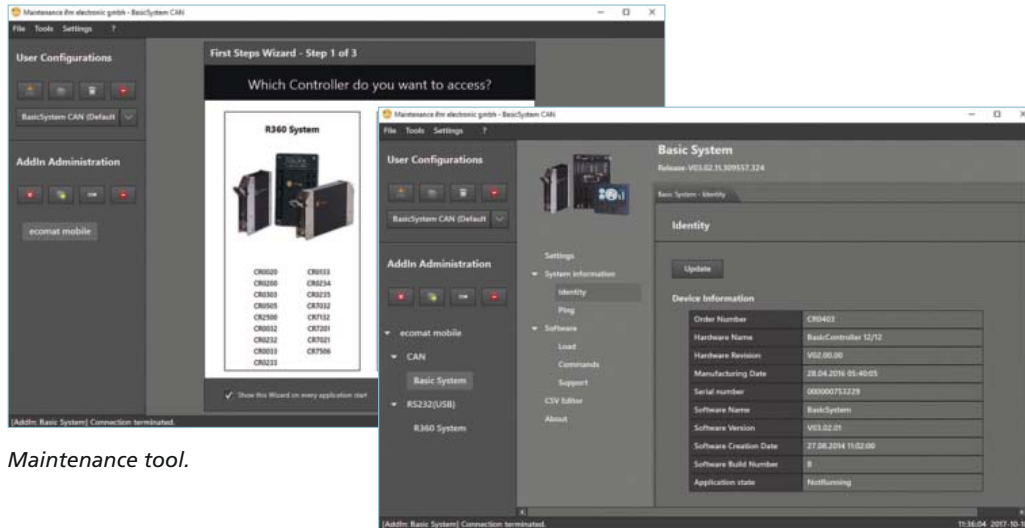

Maintenance tool.

Devices for remote maintenance · CAN-bus diagnostics · CAN-USB interface cable

CANwireless

Local access to the CAN bus via Bluetooth or wifi.



| Description | Connection | Order no. |
|--|-------------------------------------|-----------|
| CAN to wifi / Bluetooth, CANwireless with internal antenna | M12 CAN / Power M12 service port | CR3130 |
| CAN to wifi / Bluetooth, CANwireless for external antenna | | CR3131 |

CANremote

Remote access to the CAN bus via mobile radio network, integrated GPS.



| Design | Connection | Order no. |
|--|--|-----------|
| 2G/3G radio modem for the bidirectional data exchange with the ifm mobile IoT platform. GPS/Glonass for position detection of the machine, SD card slot for local data storage, SIM card slot allows free selection of a network provider. | M12 connector FME connector SMA socket | CR3114 |

Download software under Service / Downloads at ifm.com

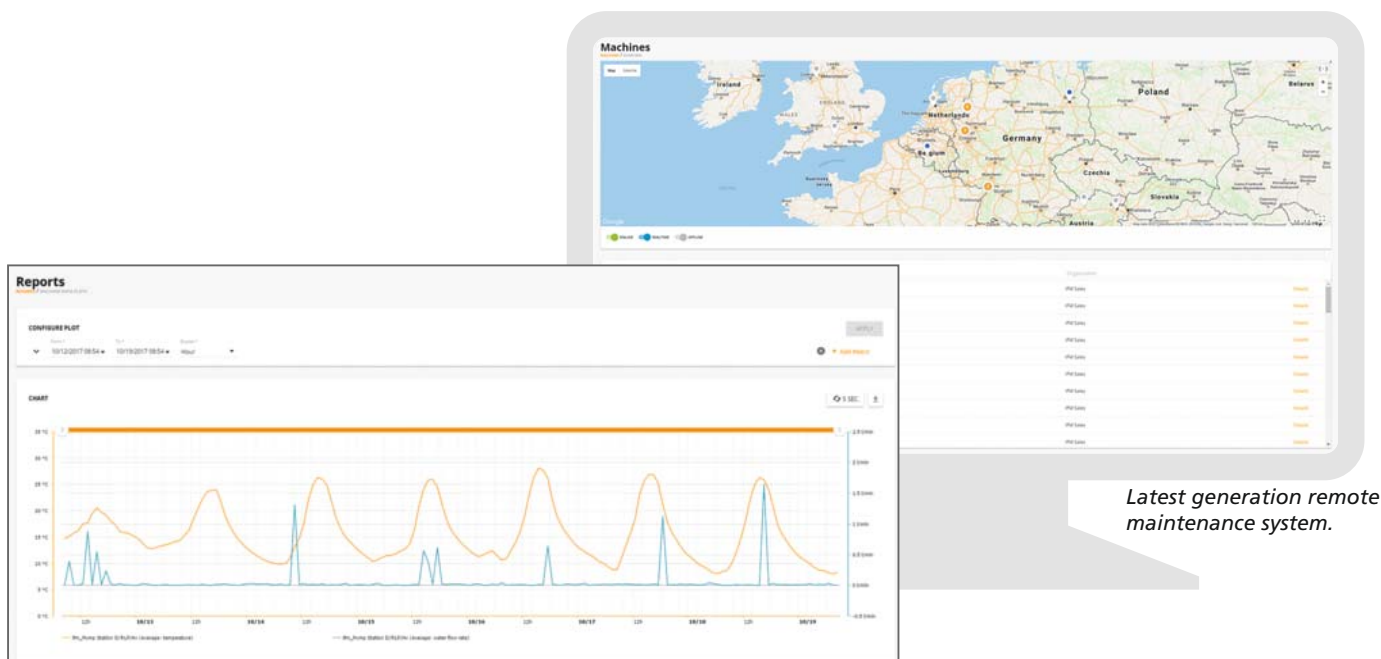

Latest generation remote maintenance system.

MobileData / MobileMaintenance

Local and remote access to the CAN bus via mobile radio network, Bluetooth or wifi.

Integrated GNSS module for position detection.



| Design | Connection | Order no. |
|--|-------------------------|----------------------|
| The latest generation of 2G/3G radio modems. GNSS for position detection of the machine, energy-saving and sleep modes, integrated acceleration and inclination sensor, for example to activate the device in sleep mode, 1 x CAN interface. | Micro Timer 2, 14 poles | CR3145 ¹⁾ |
| The latest generation of 2G/3G radio modems. GNSS for position detection of the machine, energy-saving and sleep modes, integrated acceleration and inclination sensor, for example to activate the device in sleep mode, 2 x CAN interface, wifi and Bluetooth interface for the local communication. | Micro Timer 2, 14 poles | CR3150 ¹⁾ |
| The latest generation of 2G/3G radio modems. GNSS for position detection of the machine, energy-saving and sleep modes, integrated acceleration and inclination sensor, for example to activate the device in sleep mode, 2 x CAN interface, wifi and Bluetooth interface for the local communication, connection for external 2G/3G and GNSS antenna, integrated battery. | Micro Timer 2, 14 poles | CR3155 ¹⁾ |

¹⁾device in preparation

Software

| Description |
|--|
| CODESYS V2.3 package Programming software for ecomatmobile controllers and dialogue modules including additional components |
| CODESYS V3.5 package Programming software for ecomatController and ecomatDisplay |

Other software tools, example programs and documentation are available in the ifm web shop.

Inductive sensors for mobile applications.

Sensors for mobile machines



Permitted:

E1 type approval by the Kraftfahrt-Bundesamt (German Federal Motor Transport Authority).

Resistant:

Wide operating temperature range.

Ingress-resistant:

High ingress resistance for the requirements in harsh environmental conditions.

Radiation protection:

High EMC resistance according to vehicle standards.

Flexible:

Wide input voltage range.

EMC tested

Electric discharge, high voltage and electromagnetic fields: ecomatmobile products are protected against noise pulses by the housing. The electronics on the inside are protected.



Tough

Whether in iciness, during thunderstorms or in continuous rainfall: the sensors for mobile applications resist the worst environmental conditions. Here at a spreader in port logistics.



Not found the right sensor yet?
More details at ifm.com



Position detection under harsh conditions

Sensors are also used in mobile machines and installations. In contrast to devices for industrial automation, the demands on sensors for mobile applications are much higher. As they are installed in exposed positions, they have to meet special requirements.

The devices are designed to ensure highest shock and vibration resistance. In combination with the connectors of the ecolink EVM series, the inductive sensors of the M series are the perfect combination for mobile applications. The sensors have a temperature range of -40...+85 °C so that they can operate reliably in extremely cold conditions and when installed next to hot engines. Moreover, the devices are insensitive to rapid temperature changes.

A voltage range of 10 V up to 60 V for mobile sensors ensures that even high fluctuations of the on-board system do not affect the function. To comply with the ever increasing EMC requirements in mobile applications the devices feature an increased EMC resistance.

The sensors have the E1 type approval. With this approval of the German Federal Office for Motor Traffic they are allowed for use in road vehicles without expiry of their operating permit.

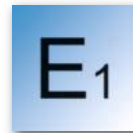
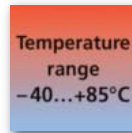
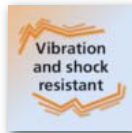

Type IFM / IGM / IIM inductive sensors

For mobile applications.

| Dimensions [mm] | Sensing range [mm] | Connection | Output | Order no. |
|-----------------|--------------------|------------|----------------|-----------|
| M12 / 60 | 4 f | M12 | DC PNP/NPN; NO | IFM213 |
| M12 / 70 | 7 nf | M12 | | IFM204 |
| M18 / 70 | 8 f | M12 | | IGM200 |
| M18 / 70 | 12 nf | M12 | | IGM201 |
| M30 / 70 | 12 f | M12 | | IIM200 |
| M30 / 70 | 22 nf | M12 | | IIM201 |
| M12 / 79 | 4 f | cable, 6 m | DC PNP/NPN; NO | IFM207 |
| M12 / 79 | 7 nf | cable, 6 m | | IFM208 |
| M18 / 81 | 8 f | cable, 6 m | | IGM202 |
| M18 / 81 | 12 nf | cable, 6 m | | IGM203 |
| M30 / 81 | 12 f | cable, 6 m | | IIM202 |
| M30 / 81 | 22 nf | cable, 6 m | | IIM203 |

f: flush installation nf: non-flush installation

Magnetic sensors for mobile applications.

Sensors for mobile machines



Pressure rating:

Operating pressure up to 500 bar, bursting pressure up to 2000 bar.

Long service life:

With 10 million pressure cycles the sensor lasts as long as the cylinder.

Extremely robust:

Housing and sensing face of 1 mm thick stainless steel.

Half price:

Equipping the cylinder with two ifm sensors costs no more than a comparable sensor in this application.

Space-saving:

Housing length of only 40 mm for a low cylinder profile.

Flexible:

M12 or M14 housing, cable or M12 connector, PNP or NPN, normally open, normally closed or complementary output.



Not only for cylinders

The magnetic-inductive sensors used in municipal vehicles but also on other hydraulic components such as valves or pumps stand out with their high pressure rating.

Mechanical protection

The MFH type sensors can be screwed flush into various hydraulic cylinders. With a sensing range of 1.8 mm they reliably detect the position of the piston rod in the cylinder.





Reliable monitoring of the piston positions

The units are based on a magnetic-inductive technology which solely detects ferromagnetic metals (e.g. steel of the piston rod). Using this operating principle the stainless steel housing can have a wall thickness up to 1 mm, even at the sensing face, resulting in extremely long life and high reliability.

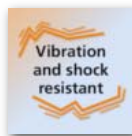
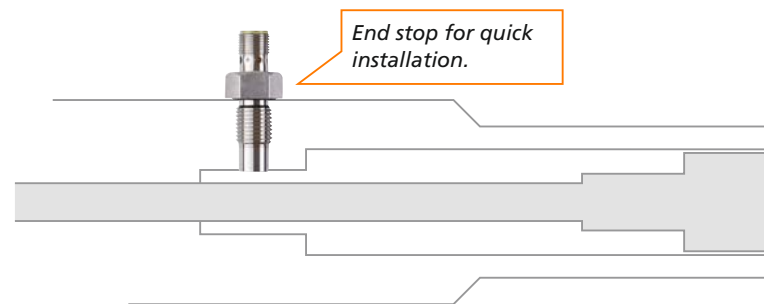

MF-type pressure-resistant magnetic sensors

For mobile applications.

| Dimensions [mm] | Sensing range [mm] | Pressure rating [bar] | Output | Connection | Order no. |
|------------------------|--------------------|-----------------------|---------|--------------|---------------|
| M12 / 93 | 1.8 f | 500 | PNP; NO | M12 | MFH200 |
| M12 / 93 | 1.8 f | 500 | NPN; NO | M12 | MFH201 |
| M12 / 60 | 1.8 f | 500 | PNP; NO | M12 | MFH202 |
| M12 / 60 | 1.8 f | 500 | NPN; NO | M12 | MFH203 |
| M12 / 60 | 1.8 f | 500 | PNP; NC | M12 | MFH204 |
| M14 / 53 | 2 f | 500 | PNP; NO | M12 | M9H200 |
| M14 / 60 | 1.8 f | 500 | PNP; NO | M12 | M9H203 |
| M12 / 60 | 60 (M 4.0) | – | PNP; NO | M12 | MF5004 |
| M12 / 60 ²⁾ | 60 (M 4.0) | – | PNP; NO | M12 | MFS211 |
| M12 / 40 | 1.8 f | 500 | PNP; NO | cable, 2 m | MFH205 |
| M12 / 40 | 1.8 f | 500 | NPN; NO | cable, 2 m | MFH206 |
| M12 / 40 | 1.8 f | 500 | PNP; NC | cable, 2 m | MFH207 |
| M14 / 40 | 2 f | 500 | PNP; NO | cable, 0.5 m | M9H201 |
| M14 / 40 | 2 f | 500 | PNP; NO | cable, 1 m | M9H202 |
| M14 / 40 | 1.8 f | 500 | PNP; NO | cable, 0.5 m | M9H206 |

²⁾full metal housing f: flush installation

Encoders and inclination sensors for mobile applications.

Sensors for mobile machines



Reliable:
CAN interface via M12 connector.

Robust:
Vibration and shock resistant.

Permitted:
E1 type approval by the Kraftfahrt-Bundesamt (German Federal Motor Transport Authority).

Resistant:
Wide temperature range of -40...85 °C.

Ingress-resistant:
High ingress resistance (IP 67 / IP 69K) for the requirements in harsh environmental conditions.



Correct alignment

2-axis inclination sensors are commonly used for position detection on working platforms or levelling of mobile cranes or excavators. An example of the pivot position measurement of the excavator bucket by means of an inclination sensor.



JN-type absolute inclination sensor
For mobile applications.

| Angular range [°] | Resolution / accuracy [°] | Interfaces | Order no. |
|-------------------|---------------------------|-----------------|---------------|
| 0...360 / ± 180 | 0.001 / < ± 0.5 | 1 x CANopen | JN2100 |
| | 0.1 / < ± 0.5 | 1 x CAN / J1939 | JN2300 |
| ± 45 | 0.001 / < ± 0.01 | 1 x CANopen | JN2101 |
| | 0.01 / < ± 0.01 | 1 x CAN / J1939 | JN2301 |



Inclination sensors – high measurement accuracy for angles and positions

Often the horizontal alignment of machines or machine parts is an important requirement for reliable operation. Inclination sensors are designed for angular position detection or levelling of mobile machines. Inclination sensors provide high measurement accuracy across the whole angular and temperature range with angles of inclination along the X and Y axes. They have a CAN interface (CANopen / SAE J1939) or IO-Link.

Multiturn encoders – Precise detection of positions and rotational movement

The multiturn encoders are used for the detection of rotation or exact position detection for rotary movements. The encoder resolves a revolution into 4096 steps. The gear-free system uses the Wiegand effect to keep the position values stored in case of a power failure without battery buffer. This means that the exact position can be transferred to the controller without any referencing.

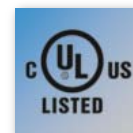
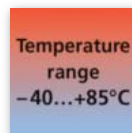
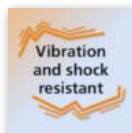

RM-type absolute multiturn encoder
For mobile applications.

| Resolution | Interface | Shaft | Order no. |
|------------|-------------|---|---------------|
| 24 bits | 1 x CANopen | synchro flange 10 mm | RM9000 |
| 24 bits | 1 x CANopen | synchro flange with flattened shaft 10 mm | RM9001 |

Exact positioning

Encoders are used in mobile machines for angle, speed and position detection. In this example each wheel is aligned to exactly 0.08°. Speed, angle and up to eight cam positions can be monitored simultaneously.



Pressure sensors for mobile applications.

Sensors for mobile machines



Compact:

Pressure transmitters without display and with analogue output.

Robust:

Stainless steel measuring cell without any seal. Vibration and shock resistant.

Flexible:

Deutsch, AMP or M12 connector.

Temperature-resistant:

-40...125 °C medium temperature.

Fast:

Response time 2 ms.

Application-specific:

Ideal for use in mobile hydraulic applications.

*PU/PT-type
pressure
transmitters
For mobile
applications.*

IP 69K test

A high-pressure water jet with 100 bar pressure at 80 °C is aimed at the object from short distance and at standardised angles.

Only units remaining ingress-resistant over a defined time obtain protection rating IP 69K.





Precise and reliable even under the highest pressure

The PT/PU-type sensors are suited for mobile applications and especially for hydraulic and pneumatic applications with high operating pressure. The high vibration and shock resistance, the high protection rating, the excellent EMC resistance and E1 conformity make the PT/PU sensors particularly suitable for use in mobile machines.

The connectors of the new pressure sensors allow fast and easy installation in mobile machines. The sensors also feature a thin-film measuring cell directly welded with the process connection. This technology guarantees high accuracy in a very compact housing with only 19 mm across flats at a cost-optimised price / performance ratio.

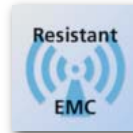
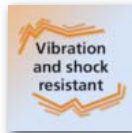

| Process connection | Measuring range Relative pressure [bar] | Order no. | Order no. | Order no. |
|----------------------------|---|-----------|-----------|-----------|
| Plug-and-socket connection | | M12 | DEUTSCH | AMP |
| Analogue output 4...20 mA | | | | |
| G 1/4 male | 0...600 | PT5560 | PT5760 | PT5660 |
| | 0...400 | PT5500 | PT5700 | PT5600 |
| | 0...250 | PT5501 | PT5701 | PT5601 |
| | 0...100 | PT5502 | PT5702 | PT5602 |
| | 0...25 | PT5503 | PT5703 | PT5603 |
| | 0...10 | PT5504 | PT5704 | PT5604 |
| Analogue output 0...10 V | | | | |
| G 1/4 male | 0...600 | | PU5760 | PU5660 |
| | 0...400 | | PU5700 | PU5600 |
| | 0...250 | | PU5701 | PU5601 |
| | 0...100 | | PU5702 | PU5602 |
| | 0...25 | | PU5703 | PU5603 |
| | 0...10 | | PU5704 | PU5604 |

| Process connection | Measuring range Relative pressure [bar] | Order no. | Order no. |
|-----------------------------|---|-----------|-----------|
| Plug-and-socket connection | | M12 | DEUTSCH |
| Analogue output 0.5...4.5 V | | | |
| G 1/4 male | 0...600 | PU8560 | PU8760 |
| | 0...400 | PU8500 | PU8700 |
| | 0...250 | PU8501 | PU8701 |
| | 0...160 | | PU8712 |
| | 0...100 | PU8502 | PU8702 |
| | 0...60 | PU8523 | PU8723 |
| | 0...25 | PU8503 | PU8703 |
| | 0...10 | PU8504 | PU8704 |

Temperature sensors for mobile applications.

Sensors for mobile machines



Matching:

Temperature transmitters with current or voltage output or PT1000.

Versatile:

Connector versions M12, DEUTSCH and AMP selectable.

Economical:

Operating voltage as of 8 V.

Robust:

Pressure resistance up to 400 bar.

Simple:

Plug and play via preset measuring ranges.

Flexible:

Different process connections and installation depths.

TA/TU-type temperature transmitters

Welded stainless steel housing.

Insertion depths of 25 to 200 mm.

T05 / T09: 1 / 3 s.

Accuracy [K]:
± 0.3 + (± 0.1 % Ms).

| Measuring range [°C] | Process connection | Insertion depth [mm] | Plug-and-socket connection | Order no. | Order no. |
|------------------------|--------------------|----------------------|----------------------------|------------------|--------------------|
| Analogue output | | | | 4...20 mA | 0.5...4.5 V |
| -50...150 | G 1/4 | 25 | M12 | TA3105 | TU3105 |
| | | 50 | M12 | TA3115 | |
| | | 200 | M12 | TA3155 | |
| | | 25 | DEUTSCH | TA4105 | TU4105 |
| | | 50 | DEUTSCH | TA4115 | |
| | | 25 | AMP | TA5105 | TU5105 |
| | 50 | AMP | TA5115 | | |
| | M10 x 1 | 50 | DEUTSCH | TA4019 | |



Temperatures in hydraulics and pneumatics under control

The compact temperature transmitters of types TA/TU/ITM are designed especially for use in mobile machines. The sensors feature high precision due to the factory-internal adjustment of the PT element and the electronics. The innovation, besides the wide measuring range, is the excellent response time. The high vibration and shock resistance enable use particularly in hydraulic and pneumatic applications with high operating pressure.

A voltage range of the temperature transmitters of 8 up to 32 V DC ensures that even high fluctuations of the on-board supply system do not affect the function. To comply with the ever increasing EMC requirements in mobile applications the devices feature increased EMC resistance. The sensors are available with different probe lengths, process connections and measuring ranges.

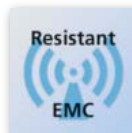
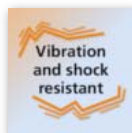

PT1000 with type TM process connection

Insertion depths of 25 to 50 mm.

T05 / T09: 1 / 3 s.

Accuracy [K]:
± (0.15 + 0.002 x |t|).

Connection to evaluation unit.

| Measuring range [°C] | Process connection | Insertion depth [mm] | Plug-and-socket connection | Order no. |
|-------------------------|--------------------|-------------------------|----------------------------|---------------|
| PT1000 | | | | |
| -40...150 | G 1/4 | 25 | M12 | TM5105 |
| | G 1/2 | 50 | M12 | TM5411 |
| | G 1/4 | 25 | DEUTSCH | TM6101 |

Find the suitable accessories at ifm.com

Use in icy environments

Thanks to their high protection rating, fully welded stainless steel housing and high pressure resistance, the transmitters are particularly suited for use in harsh environments and at extreme temperatures.



RFID for mobile applications.

Sensors for mobile machines



Integrated:

Antenna, evaluation and CANopen interface in a compact M18 or M30 housing.

Insensitive:

Extended temperature range of -40...85 °C.

Permitted:

E1 type approval by the Kraftfahrt-Bundesamt (German Federal Motor Transport Authority).

Robust:

Optimised for outdoor use with IP 67 and IP 69K, shock resistant to EN60068-2-27, vibration resistant to EN60068-2-64.

Compatible:

CANopen protocol optimised for use with ifm ecomatmobile controllers.

Completeness check

The presence of different tools on the corresponding fixtures is detected.



Detection of attachments

Different attachments are detected. The application parameters in the controller and in the operating devices are automatically adjusted.



Devices for operation and monitoring tasks
pages 16 - 19





Reliable solution for identification tasks

The robust RFID compact unit with CANopen interface has been developed for identification tasks in agricultural machines, municipal vehicles and construction machines.

It automatically detects different attachments and configures the corresponding settings in the controller.

Automatic identification simplifies the creation of user-specific system set-ups.

Information on maintenance intervals and operating times can automatically be generated and stored since the controller automatically detects when and how long a specific machine set-up runs. Downtime is kept to a minimum, productivity is increased.

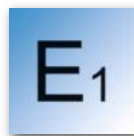
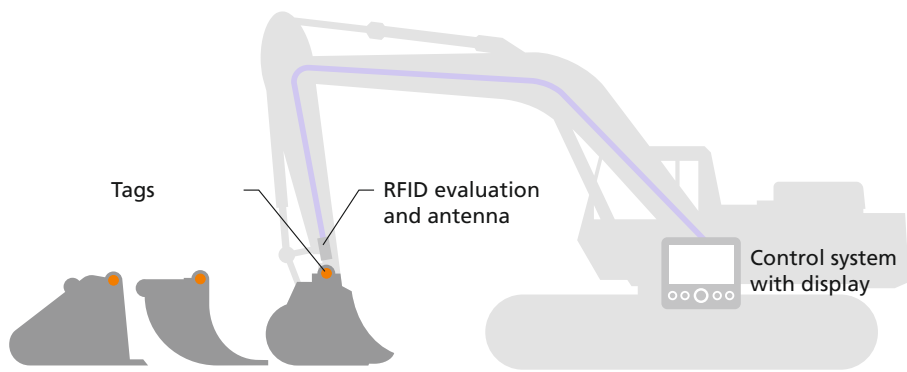

RFID evaluation unit / antenna
13.56 MHz
type DTM
 For mobile applications.

| Housing | Interface | Connection | Order no. |
|-----------------------------|-----------|-------------|---------------|
| M18, flush installation | CANopen | M12 | DTM424 |
| M18, non-flush installation | | M12 | DTM425 |
| M30, flush installation | | M12 | DTM434 |
| M30, non-flush installation | | M12 | DTM435 |
| M18, flush installation | J1939 | M12 | DTM426 |
| M18, non-flush installation | | M12 | DTM427 |
| M30, flush installation | | M12 | DTM436 |
| M30, non-flush installation | | M12 | DTM437 |
| M18, flush installation | CANopen | cable 0.8 m | DTM428 |

| Tags (selection) Design | Order no. |
|---|---------------|
| ID tag / Ø 30 x 2.8 / 03 – 13.56 MHz, 16 kbits – FRAM | E80370 |
| ID tag / Ø 30 x 2.5 / 06 – 13.56 MHz 896 bits | E80371 |
| ID tag / Ø 20 x 2.5 / 06 – 13.56 MHz 896 bits | E80377 |
| ID tag / Ø 30 x 2.8 / 03 – 13.56 MHz, 64 kbits | E80380 |

Still looking for more choice? You can find more tag versions at ifm.com

ecolink connection technology for mobile applications.

Connection technology and accessories



Ingress-resistant:

The innovative sealing concept provides the high protection ratings IP 67 / IP 68 / IP 69K.

Held in place:

The saw-tooth type vibration protection ensures that the nut does not become loose unintentionally in case of shock and vibration.

By hand:

Easy to install and remove manually.

Visible:

Versions in a transparent black housing for an optimum visibility of the LED even in bright lighting conditions.

Standardised:

The connection technology meets the M12 standard EN 61076.

Tested to extremes

Again and again immersed in icy and boiling water: the connection remains ingress-resistant.



Easy mounting without using a tool.

Vibration protection with end stop

The saw-tooth type vibration protection ensures that the nut does not become loose unintentionally in case of shock and vibration.

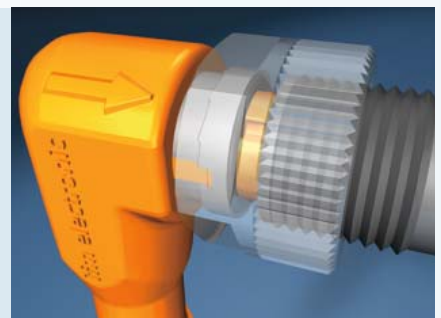



Reliable even in mobile applications

Overpressure impossible: Due to the special installation of a mechanical end stop the O-ring is always correctly compressed and so permanently maintains its sealing function.

The saw tooth contoured vibration protection secures against strong shocks and vibrations. The high protection rating IP 67 / IP 68 / IP 69K, the wide temperature range of -40...90 °C as well as high-quality housing materials (high-grade stainless steel, TPU) ensure a permanently reliable connection in harsh environments such as salty moisture, oil and grease.

Clearly visible: The innovative design and a transparent black housing ensure that, even in bright lighting conditions, the LEDs are more clearly visible than with clear transparent versions. This is an important prerequisite to keep an eye on the plant status all the time and to be able to act quickly in case of problems.

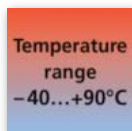

Connection cables with M12 socket

Sensor connection technology for mobile applications.

| Housing | Cable [m] | LEDs | Order no. |
|------------------------|-----------|------|-----------|
| Straight, M12, 4 poles | 2 | – | EVM001 |
| | 5 | – | EVM002 |
| | 10 | – | EVM003 |
| Straight, M12, 4 poles | 2 | • | EVM068 |
| | 5 | • | EVM069 |
| | 10 | • | EVM070 |
| Angled, M12, 4 poles | 2 | – | EVM004 |
| | 5 | – | EVM005 |
| | 10 | – | EVM006 |
| Angled, M12, 4 poles | 2 | • | EVM007 |
| | 5 | • | EVM008 |
| | 10 | • | EVM009 |

Accessories for control systems.

Connection technology and accessories

Controllers



| Design | Order no. |
|--|---------------|
| Mini controllers | |
| BasicRelay | CR0421 |
| BasicController cover | EC0401 |
| Basic cover with recess | EC0402 |
| Mounting frame BasicDisplay CR0451 | EC0403 |
| Mounting frame BasicDisplay XL CR0452 | EC0404 |
| BasicDisplay RAM set | EC0405 |
| BasicDisplay XL RAM set | EC0406 |
| BasicController connection set | EC0456 |
| BasicRelay connection set | EC0457 |
| CR0431 connection set | EC0464 |
| CR0431 voltage connection set | EC0465 |

| Diagnostics and service | |
|---|---------------|
| GSM/GPS antenna for CR3114 | EC2116 |
| Wifi/Bluetooth antenna for CR3131 | EC2118 |
| GSM/GPS antenna for CR3155 | EC2119 |
| Connection cable for parameter setting and set-up for CR3145/50/55 | EC3145 |
| Connection cable, 14 poles for CR3145/50/55 | EC3146 |
| Connection set, 14 poles for CR3145/50/55 | EC3147 |

| Devices with 55-pole connection | |
|--|---------------|
| Plug set, 55 poles | EC2013 |
| Connection cable, 1.2 m, sealed | EC2084 |
| Connection cable, 2.5 m, sealed | EC2097 |
| Connection cable, 1.2 m | EC2086 |
| Connection cable, 2.5 m | EC2046 |

| CabinetController | |
|--------------------------|---------------|
| Plug set for CR0303 | EC2090 |

| Design | Order no. |
|--|---------------|
| Mini controllers | |
| CR0431 12 V relay set | EC0466 |
| CR0431 24 V relay set | EC0467 |
| CANfox | EC2112 |
| CANfox cable | EC2113 |
| Basic programming cable | EC2114 |
| Connection cable BasicController | EC0451 |
| Connection cable Controller display, 0.1 m | EC0452 |
| Connection cable Controller display, 5 m | EC0454 |
| Connection cable two controller displays, 5 m | EC0455 |
| Connection cable with socket, 5 poles, with 120 ohm resistor, 5 m | EVC492 |

| Software | |
|---|---------------|
| Communication module for software development (Windows / Linux) | CP9030 |
| Communication module for CODESYS software development on ifm displays (Linux) | CP9031 |
| ISOBUS / virtual terminal client | CP9200 |
| Programming software CODESYS 2.3 D/GB Tools and documentation | CP9040 |
| Programming software CODESYS 3.5 D/GB Tools and documentation | CP9041 |



| ecomatController | |
|---------------------------------------|---------------|
| Connector, 81 poles, A-coded | EC0701 |
| Connector, 81 poles, B-coded | EC0702 |
| Connection cable, A-coded, for CR710S | EC0710 |
| Connection cable, A-coded, for CR7xxS | EC0711 |
| Connection cable, B-coded, for CR720S | EC0720 |
| Connection cable, B-coded, for CR721S | EC0721 |



Download of the programming software free of charge under Service / Downloads at ifm.com

Dialogue modules



| Design | Order no. |
|----------------------------|---------------|
| PDM360 NG | |
| RAM mounting plate, C size | EC1410 |
| RAM arm, standard (144 mm) | EC1412 |
| 7" mounting frame | EC2110 |
| 12" mounting kit | EC2117 |

| Design | Order no. |
|----------------------------|---------------|
| ecomatDisplay | |
| Connection cable, 40 poles | EC0705 |
| Connector with contacts | EC0706 |
| 5" mounting kit | EC0730 |
| 7" mounting kit | EC0731 |
| 12" mounting kit | EC0733 |

I/O modules



| Design | Order no. |
|--|---------------|
| I/O modules | |
| Connection cable, 1.2 m, 6 poles | EC1520 |
| Connection cable, 1.2 m, 10 poles | EC1521 |
| Connection cable, 1.2 m, 14 poles | EC1522 |
| Connection cable, 1.2 m, 18 poles | EC1523 |
| CR2014 / CR2014 plug set | EC2053 |
| CAN jumper, 5 poles, 2 m | E11593 |
| Can connection cable with socket, 5 poles, 2 m | E11596 |
| CAN connection cable with plug, 5 poles, 2 m | E11598 |

| Design | Order no. |
|---|---------------|
| ioControl | |
| ioCable / DT-06 / 1 x 3 poles / 2 m / PUR | E12544 |
| ioCable / DT-06 / 2 x 3 poles / 2 m / PUR | E12547 |
| ioCable / DT-06 / 1 x 2 poles / 2 m / PUR | E12550 |
| ioCable / DT-06 / 2 x 2 poles / 2 m / PUR | E12553 |
| ioCable / DT-06 / 4 poles / DT-06 / 2 m / PUR | E12557 |
| Protective cover for DEUTSCH sockets | E12574 |
| 120 ohm resistor DEUTSCH connector | E12575 |
| AMP connector with contacts | E12582 |
| DEUTSCH connection plug with contacts | E12583 |
| AMO connection cable, 2 m | E12565 |
| AMO connection cable, 5 m | E12566 |



Still looking for more choice? For more accessories see ifm.com



Go ifmonline!

Inform, select, order
in the ifm webshop

ifm.com



ifm – close to you!



Position sensors



**Sensors for
motion control**



Industrial imaging



Safety technology



Process sensors



**Industrial
communication**



IO-Link



Identification systems



**Condition monitoring
systems**



**Systems for
mobile machines**



**Connection
technology**



Software



Power supplies



Accessories

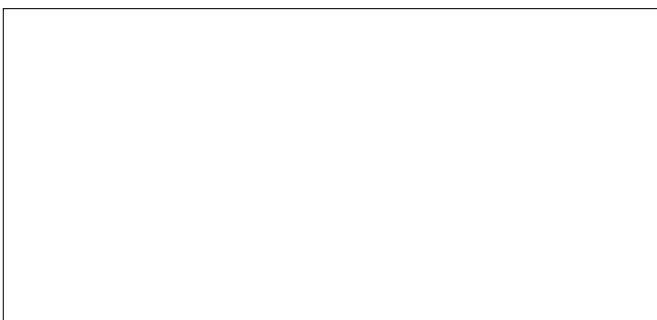

ifm electronic gmbh
Friedrichstraße 1
45128 Essen
Tel. +49 / 201 / 24 22-0
Fax +49 / 201 / 24 22-1200
E-mail info@ifm.com

